

# Onis Vox 380

**Onis 380 Vox**

**Onis 380 Duo Vox**





**Charge handset(s)  
for 24 hours before use.**

**This equipment is not designed for making  
emergency telephone calls when the power fails.**

# PHILIPS

# Menu overview

By using the “pilot key”  on the side of the handset you can scroll  through the menus

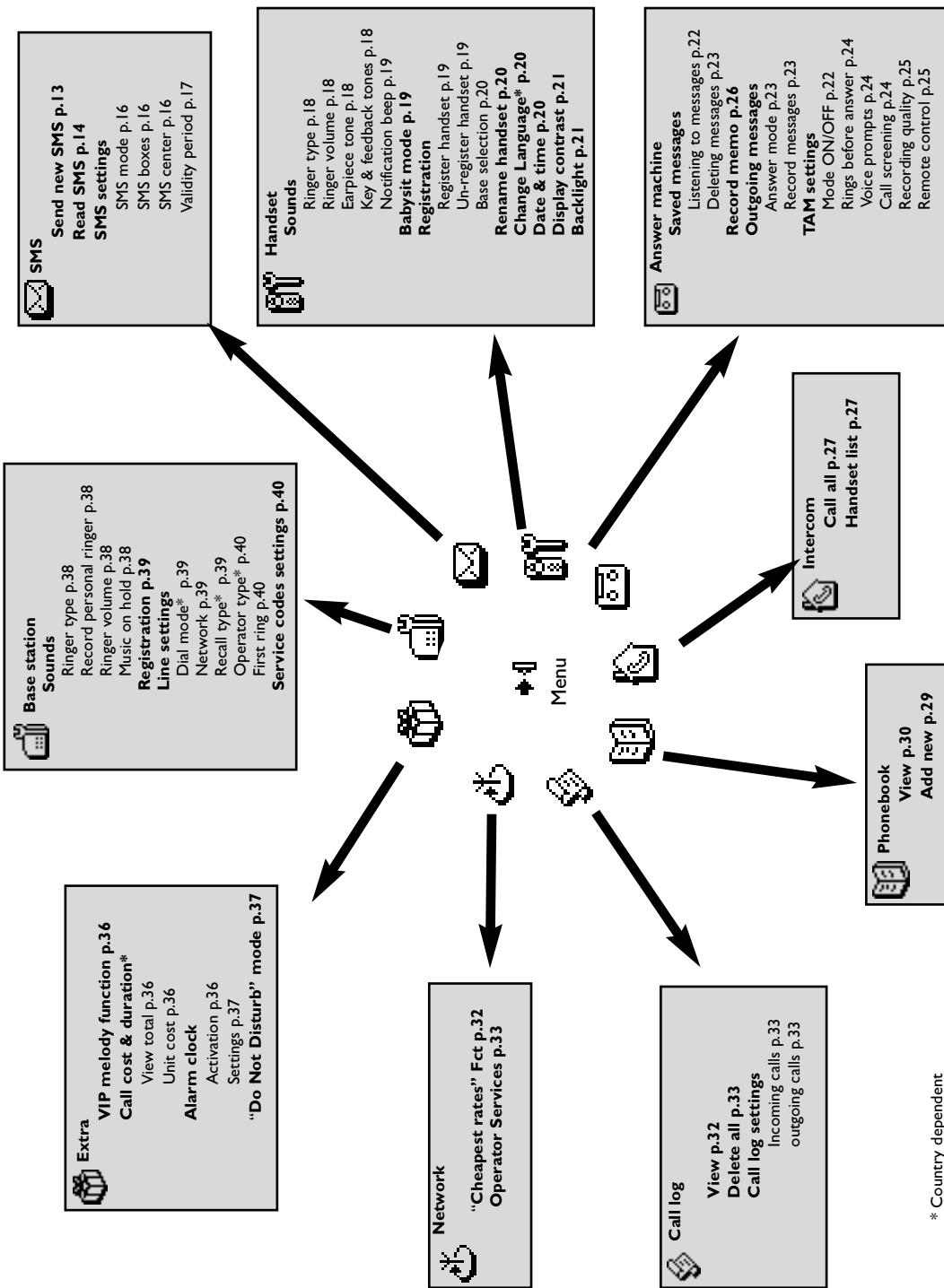

\* Country dependent

# Onis 380 Vox Handset

**Pilot key**

- Press to enter the carousel or validate a menu/option
- Scroll to navigate the menus & options
  - Move the cursor left/right
  - Scroll up to reach **Intercom** from idle mode
  - Scroll down to reach **Cheapest rates** from idle mode
- A long press to unlock the keypad

**Loudspeaker**

- A short press to take the line or activate the handset loudspeaker during a call
- A long press to activate the base loudspeaker

**Call log**

- A short press to access the call log
- A long press to directly access the vocal message list

**Keypad lock & Edition**

- A short press to insert \*
- A long press to lock/unlock the keypad in idle mode
- A long press to insert R when predialling
- A long press to switch multimap or Eaton editor when editing

Earpiece

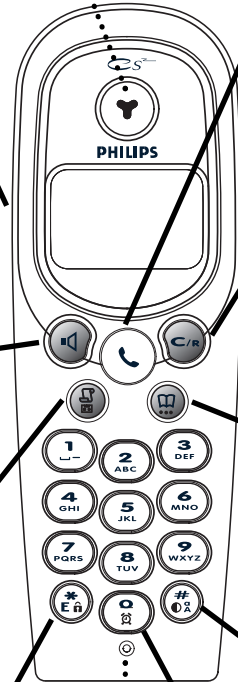

**Line key**

- Press to take the line, answer a call or hang up.

**C/R Correct key**

- To correct a digit when predialling or a character when editing
- A short press to go back one menu when navigating
- A long press to return to idle mode when navigating
- To insert R for operator services when on line

**Phonebook**

- A short press to access the phonebook
- A long press to add a new entry

**# Do not disturb & case mode**











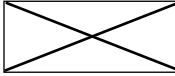

- A short press to insert # when dialling
- A long press to activate/deactivate the "Do Not Disturb" mode
- A long press to insert a pause (P) when dialling
- Press to switch case mode when editing

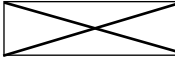
**Alarm clock**

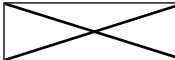

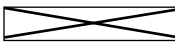
- A short press to dial 0
- A long press to activate/deactivate the alarm clock





Microphone

## Icons on the display

	Steady ON	Blinking	Fast blinking
	Answer machine ON	New message on answering machine or voice mailbox	Answer machine full
	External call in progress	- Incoming external call in progress - Line is already busy	
	Internal call in progress	Internal incoming call	
	Handset loudspeaker ON	Base loudspeaker ON	
	Ringer deactivated		
	SMS function ON	New SMS	SMS memory full
	Registered & in range of the base station	Not registered	

## The battery symbol

When charging, the battery bars scroll :   

When the handset discharges, the icon shows the status: Full , 2/3 , 1/3  and empty .

## Information on the base station display

The base display lights up when the answer machine is activated.

The number of read messages is displayed (steady).



The number of new messages is displayed (blinking).

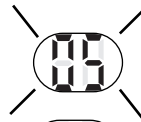

When the mute feature is activated on the base, the display shows



When listening to a message, if you press  (pause), the display shows



When recording a memo from the base station, recording a conversation or when a message is being left, the display shows a scrolling



When the answer machine is full, the number of messages blinks fast.

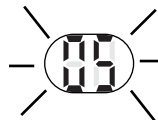

# Onis 380 Vox Base station

The base station can be used to make calls just like a handset.

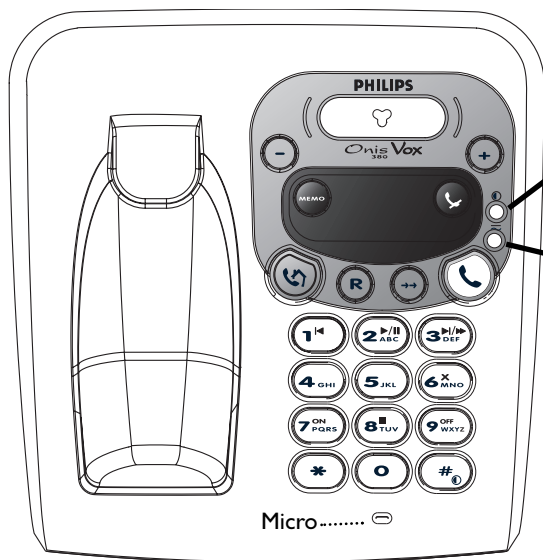



**Do Not Disturb indicator (red)**

**ON** : The mode is activated  
**OFF** : The mode is deactivated

**Power indicator (green)**

**ON** : System correctly connected to the mains  
**OFF** : System not powered  
**Blinking** : The line is busy  
**Blinking fast** : Call transfer in progress

 Decrease the volume of the base loudspeaker and deactivate call screening

 Increase the volume of the base loudspeaker and activate call screening

 To page all handsets when in idle mode or make a direct call transfer when on line

 To record a memo when in idle mode. To record a conversation when on line, press again to stop recording

 To use the operator services

 To redial the last number called from the base (see page 8).

 To take the line, make the call and answer a call

 To mute the microphone when on line. Press again to unmute.

## Answer machine control keys (see page 8 for more information)

 One press to go back to beginning of message. Two quick presses to go back to previous message

 Press to listen to the messages or pause when listening to messages

 A long press to fast forward a message. Press to go to next message

 Press to erase the current message. A long press to erase all the already read messages

 To activate the answer machine. When the answer machine is on, press to listen to the current outgoing message

 To stop the listening of the current message

 To deactivate the answer machine

 Press to active or deactivate the "Do Not Disturb" mode

# Table of contents

<b>Handset Onis 380 Vox</b>	<b>2</b>	Setting the call screening	24
<b>Icons on the displays</b>	<b>3</b>	Setting the recording quality	25
<b>Base station Onis 380 Vox</b>	<b>4</b>	Activating the remote control	25
		Using the remote control	25
<b>Table of contents</b>	<b>5</b>	Changing the remote control code	26
		Recording a local message (memo)	26
Installing the base station	6	<b>Using the intercom</b>	
Installing and replacing the batteries	6	Making Internal calls/ activating babysit mode	27
Battery life and range	6	Transferring a call from the handset	27
		Using conference call	28
Basic use of the base station	7	<b>Using the phonebook</b>	
In-call features on the base station	7	VIP settings	29
Advanced features of answer machine	8	Adding a name	29
		Calling from phonebook	29
<b>Introduction</b>		Viewing the phonebook	30
Screen in idle mode	9	<b>Using the call log</b>	
Understanding the menu system	9	Viewing the call log	32
How to navigate in the menus	9	Deleting the call log	33
		Setting the call log	33
<b>Calling/answering calls/other principles</b>	<b>10</b>	<b>Network</b>	
		Using the Cheapest Rates Function	34
<b>In-call features</b>	<b>11</b>	Using the operator services	35
		<b>Using the extra features</b>	
<b>Editing systems</b>	<b>12</b>	Setting the VIP melody	36
		Setting the Call cost and duration	36
<b>SMS</b>		Setting the alarm clock	36
Sending new SMS	13	Setting the "Do Not Disturb" mode	37
Reading the SMS list	14	<b>Base station</b>	
SMS settings	16	Setting the ringer type	38
		Recording the personal ringer	38
<b>Handset</b>		Setting the ringer volume	38
Setting the ringer type	18	Setting music on hold	38
Setting the ringer volume	18	Registration mode	39
Setting the earpiece tone	18	Line settings	39
Setting the key & feedback tones	18	Setting the service codes	40
Setting the notification beep	19	<b>GAP standard</b>	<b>41</b>
The babysit mode	19	Conformity, environment & safety	42
Registering an additional handset	19	Declaration of conformity	42
Unregistering a handset	19	<b>Troubleshooting</b>	
Using the Onis 380Vox handset with several base stations	20	<b>Index</b>	
Renaming the handset	20		
Changing the language	20		
Setting the date and time	20		
Setting the display contrast	21		
Setting the backlight	21		
<b>Using the answer machine</b>			
Setting the answer machine ON/OFF	22		
Listening to your messages	22		
Deleting messages	23		
Selecting the answer mode and the outgoing message type	23		
Recording your personal outgoing message	23		
Setting the number of rings before answering	24		
Setting the voice prompts	24		

Philips has marked the battery and packaging with standard symbols designed to promote the recycling and appropriate disposal of your eventual waste.

 A financial contribution has been paid to the associated national recovery & recycling system.

 The labelled packaging material is recyclable.

DECT™ is a trade mark of ETSI registered to the benefit of the implementers of the DECT technology.

## Installing the base station

To properly install the base station, plug the line cord and the power cable into the base station. Plug the cord and the cable into the wall socket. The green indicator on the base station indicates that the phone is properly installed.

**Warning !** The electrical network is classified as dangerous according to criteria in the standard EN 60-950. The only way to power down this product is to unplug the power supply from the electrical outlet. Ensure the electrical outlet is located close to the apparatus and is always easily accessible.

**Warning :** Always use the cables provided with the product.

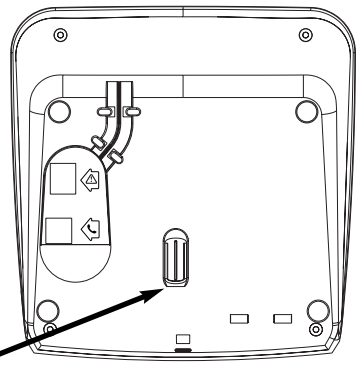

Do not insert anything in this opening

## Installing and replacing the batteries

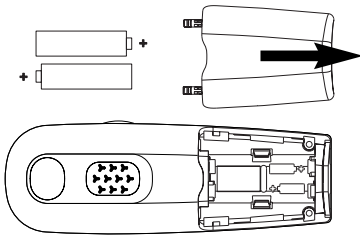

To insert the batteries, open the battery cover, place the batteries as indicated and put the battery cover back. When the handset is placed on the base, the 3 battery bars scroll (if charge is needed). Allow the handset to charge for 24 hours to reach full charge. On first use it may be necessary to wait for a few minutes before seeing symbols on the display.

In case you need to change the batteries, the following type is mandatory R03/AAA NiMh 600/650 mAh.

**Warning :** It is advisable to plug the base station into the mains when charging. Always use rechargeable batteries.



Batteries should not be disposed of with general household waste.

## Battery life and range

The battery life is about 250 hours in stand by time (when the handset is in idle mode & ready to receive a call) and around 16 hours in communication. A low battery alert will inform you that the handset has to be charged, if this is during a call, the call will end shortly after the alert.

**Optimal battery life is reached after 3 cycles of full charge/discharge.**



Under ideal conditions the range is a maximum of 50 meters indoors and 350 meters outdoors. When reaching the range limit, the conversation will become crackly, move closer to the base station otherwise the call will be cut off. To reach optimal range place the base station away from electrical appliances.

# Basic use of the base station

## Making a call from the base

Connect the line  and dial from the base station keypad

## Answering/ending a call on the base

When the phone rings, press  to answer the call. Press again  to end the call.

## Redial (Redial last number called from the base)

Press  and then 

## To activate/deactivate the “Do Not Disturb” mode from the base

Press  to activate/deactivate this mode with your own settings.

## In-call features on the base station

During an external call, you can access from the base to additional features.

### To mute the base microphone when on line

1- Press 

The caller can no longer hear you, but you can hear him.

To resume the conversation press again .

### Call transfer from the base

During an external call, you can transfer the call to handset from the base station

1- press 

2- The caller hears music (if music on hold is activated)



3- All the handsets ring

4- Answer the call on any handset.

The caller is directly transferred to the handset

If no handset answers, after a while the base will ring again, resume the call on the base, by pressing  again.

### To record a memo on the base in idle mode

To start recording press , speak close to the base and press again 



### To record a conversation on the base when on line

To start recording press , press again  to stop recording.

The call is recorded on the answer machine for a maximum of 6 mins. It automatically stops if the answer machine gets full.





## To increase/decrease the base loudspeaker volume during a call

Press  /  on the base station as many times as necessary.

## Call waiting

If you are subscribed to this service, a beep informs you of a second incoming call.

To answer the second call press  then  (according to your network, the code may be different).

Please contact your operator for more details.

## Answer machine features

### To switch the Telephone Answer Machine (TAM) ON/OFF from the base

From the base station press  to activate the answer machine.

Once activated the display on the base is lit.

With that key you can activate the answer machine even when the phone is ringing.

When the answer machine is ON, press to listen to the current outgoing message.

To deactivate it press . The display switches off.

### To listen to your messages from the base

Press  to retrieve the messages or to pause while listening

Press  to go back to the beginning of the message

Keep pressing  to fast forward a message.

The message is played fast but is very audible.

Press to go to next message.

Press  to stop listening to the message.

### To delete messages from the base

Press 



A short press on the key deletes the message while played.

A long press deletes all the messages (except unread ones).

**The number of messages blinks fast on the base display when the answer machine is full.**

### Call screening “call by call” on the base

Call screening is activated by default, you can permanently deactivate it (see page 24).

Press  /  to increase/decrease the base loudspeaker volume or even activate/mute the loudspeaker on a call by call basis.

# The screen in idle mode

In idle mode, the Onis 380 Vox display shows different information :



In normal idle mode the display shows the date & time, the name of the handset and the instruction for using the menu.



Missed call , new SMS or new messages (answer machine) or (voice mailbox), if any, are displayed in idle mode. Press the “pilot key” on the side of the handset to reach the corresponding menu.



“Do Not Disturb” mode and the alarm clock if activated, are also displayed on the idle screen.

To modify these settings use & on the keypad.

## Understanding the menu system



To access the carousel menu from idle mode press on the side of the handset.

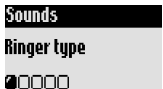

The carousel represents a loop of icons that gives access to the different first level menus. Scroll up or down to reach the desired menu. Press to validate.

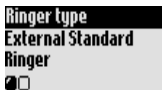

The sub menus are listed and represented by little squares at the bottom of the display. To reach one particular sub menu use the “pilot key” and press to validate your choice.

A “tick” shows the selected sub-menu or option. The shows the option you are browsing.

Note : Certain menus are also directly accessible via a dedicated key on the keypad (example Phonebook , Call log ).

## Example of navigation in the menus

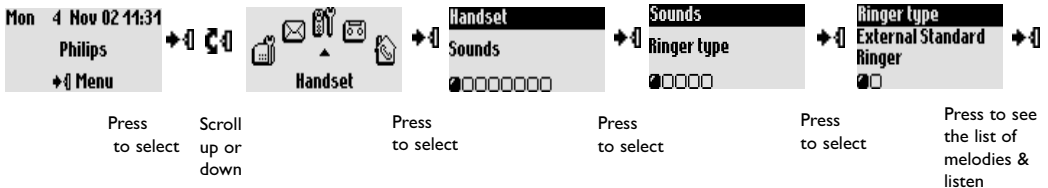

To reach the ringer type menu





# Basic principles

## Making a call from the handset

### Predialling





- 1- Dial from keypad  
To correct a digit use 
- 2- Make the call   
Talk to the other party
- 3- Hang up 

### Direct dialling

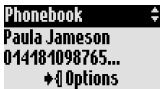
- 1- Connect the line 
- 2- Dial from the keypad  
Talk to the other party
- 3- Hang up 

## Calling from phonebook



- 1-  to enter carousel
- 2-  to reach the phonebook menu
- 3-  to select the menu,
- 4-  to reach the name
- 5- Select **Call** in the options or make the call 

Note :You can also press  to directly reach the phonebook

## Answering/ending a call

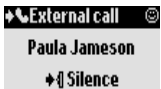



When the phone rings, press  to answer the call.

To stop the handset from ringing without answering, press  to select **Silence**

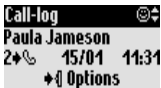
## Calling from the call log (Redial or call back last caller)







You can redial a number through the call log list. Press  and select from the list.

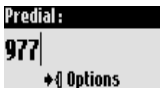

Press  to enter the options and select **call** or directly press .

## To chain dial (predial mode)



You can chain dial 2 numbers. (One predialled and the other from the phonebook or the call log, or both from the phonebook)

- 1- Predial the number (for example operator prefix)
- 2- Use  or  to open the call log or the phonebook
- 3- Scroll  through the list
- 4- Select an entry and validate 

You can move the cursor , erase or change a digit with 

- 5- Connect the line 

# In-call features

During an external call you can access additional features available in the in-call options.

Press **☛** to enter the options.



## To mute the handset microphone

1- Press **☛**

2- Scroll **☛** to **Mute** and validate **☛**

The caller can no longer hear you.

To resume the conversation press again **☛** to **Unmute**.



## Intercom (if there are several Onis 380 Vox handsets)

During a call, you can put a call on hold, transfer an external call or share the conversation on conference call : 1 external call + 2 internal callers (See page 27, 28)

## To record a conversation

1- While on line Press **☛**

2- Scroll **☛** to **Record** and validate **☛**

The call is recorded on the answer machine for a maximum of 6 minutes. To continue recording resume from step 1 above.

To listen to the conversation go to the Call log menu or the messages list (**☑**).

**Warning** : Record a conversation may be illegal. We advise you to inform the person you are calling.



During an internal call, other in-call features are available, such as **Switch** and **End intercom**.

## To switch the loudspeaker ON/OFF

Press **☎** to activate/deactivate the loudspeaker on the handset.

A long press activates the base loudspeaker.

## To increase/decrease the handset earpiece or loudspeaker volume during a call

Scroll the pilot key up or down **☛** on the side of the handset.

Or use **+** **-** on the base station.

## Call screening “call by call” on the handset.

While the caller is leaving a message, press **☛** to listen and press **☛** again to stop listening.

Adjust the volume with **☛**.

## CLI/Call waiting

If you are subscribed to this service, a beep in the earpiece informs you of a second incoming call. The name or the number of the second caller may be displayed on the screen if you are also subscribed to the Caller Line Identification service.

To answer the second call press **☎** then **☎** (according to your network, the code may be different). Please contact your operator for more details.

# Editing systems

## Using capital letters

By default, the first letter of a sentence is in upper case. Use to change the case mode : all characters in upper case (AB) or all letters in lower case (ab).

Punctuation and mathematical symbols are available through while other special characters are available through . Scroll to move the cursor left or right. Press to delete a character ; a long press deletes the whole text.

Onis 380 Vox uses two editing systems : Multi-tap and Eatoni. Make a long press on to switch between both systems. Below both systems are compared to write “Peter”.

**The standard multi-tap system** allows you to enter the text character by character, pressing the corresponding key as many times as necessary to reach the desired character.

To write “Peter” with Multi-tap system”

Press once : P

Press twice : Pe

Press once : Pet

Press twice : Pete

Press three times : Peter

### Keypad Keys

1  
2  
3  
4  
5  
6  
7  
8  
9  
0

### Multi-tap Sequence

[space] | @ \_ # = < > ( ) & € £ \$ ¥  
a b c 2 à ä ç å æ  
d e f 3 è é Δ φ  
g h i 4 ì Γ  
j k l 5 Λ  
m n o 6 ñ ò ö  
p q r s 7 β Π θ Σ  
t u v 8 ù ü  
w x y z 9 φ Ω Ξ Ψ  
. 0 , / ; " ' ! ; ? ; \* + - %

**The Eatoni system** is a new predictive editing system designed to help you write a text.

A small E in the header helps you know the mode you are using.

Eatoni is a word editor that chooses the most probable character.

The operation of the Eatoni system is the following :

Press the key that displays the character you want to edit. The character that is the most likely to be correct is displayed on the screen. If it does not match the expected character, press to display the next most probable character available on the key.

To write “Peter”  
with Eatoni



Press to activate Eatoni



Press



Press to change character



Press

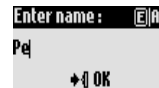

Press



Press



Press

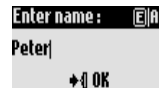

Press to validate the name





Eatoni® & LetterWise are trademarks of Eatoni® Ergonomics, Inc., and used by Philips under license.



 **SMS (Text messages)**

- Send new SMS
- Read SMS
- SMS settings

**Navigation reminder :**

-  (Go to)  (Validate)
-  (Scroll to)  (Select)

SMS stands for Short Message Service. SMS are short text messages sent/received via the network. To benefit from this service you must subscribe to the Caller Display service (CLI) from your network provider.

SMS can be exchanged with a phone (mobile or compatible fixed lines), a fax or an E-mail (country dependent), if the receiver has also subscribed to the CLI & SMS services.

**⚠ The Onis 380 Vox factory settings correspond to the main national operator. If you wish to send or receive SMS through another operator you must set the corresponding numbers (see page 16).**

You have the possibility of opening 10 SMS boxes (country dependent) one shared & 9 private to increase confidentiality.

A password can protect your SMS box, but it is not compulsory.

To send an SMS to the receiver's own SMS box, you must know his destination box (if needed).

The delivery report may be charged. It is deactivated by default, activate it when you send an SMS.

## Sending new SMS



### To send an SMS to a phone

- 1- Go to **SMS**, validate
- 2- Select **Send new SMS**, validate
- 3- Choose your SMS box & enter the password (if you have created several SMS boxes), validate
- 4- Select **Send SMS to a Phone**, validate
- 5- Dial the number (you can use the call log or the phonebook)
- 6- Enter the destination box (if prompted to), validate
- 7- Input the text (See page 12)
- 8- Scroll to **Delivery report** to activate it if necessary, validate
- 9- Select **Send Now**, validate

NB :The Delivery report option is country dependent

The outgoing SMS can be up to a maximum of 160 characters long (E-mail address included).

The special character € counts for 2.

Onis 380 Vox can store up to 100 SMS (depending on the length of the SMS) for the 10 SMS boxes.



**Send New SMS**  
 Send SMS to a Fax  
 □□□

### To send an SMS to a fax number (country dependent)

- 1- Go to **SMS**, validate
- 2- Select **Send new SMS**, validate
- 3- Choose your SMS box & enter the password (if you have created several SMS boxes), validate
- 4- Scroll to **Send SMS to fax**, validate
- 5- Input the text (See page 12)
- 6- Select **Send Now**, validate



**Send New SMS**  
 Send SMS to an E-mail  
 □□□

### To send an SMS to an E-mail address (country dependent)

- 1- Go to **SMS**, validate
- 2- Select **Send new SMS**, validate
- 3- Choose your SMS box & enter the password (if you have created several SMS boxes), validate
- 4- Scroll to **Send SMS to an E-mail**, validate
- 5- Enter the E-mail address, validate
- 6- Input the text (See page 12)
- 7- Scroll to **Delivery report** to activate it if necessary, validate
- 8- Select **Send Now**, validate

**Paula Jameson**  
 Send now  
 ●□□□

## Reading the SMS

The SMS list contains the saved and received SMS. The received SMS are shown by  and the saved SMS are shown by .

When reading the list of received SMS, some options are only available for SMS sent from a phone. Those options are **Reply**, **Forward to phone**, **Copy to phonebook** and **Call**. They automatically use the sender's own destination box.

**Choose SMS Box**  
 SMS Box 2  
 □□□

### To reply to a new SMS

- 1- Go to **SMS**, validate
  - 2- Scroll to **Read SMS**, validate
  - 3- Choose your SMS box & enter the password (if you created several SMS boxes), validate
  - 4- Select the SMS from the list
  - 5- Scroll to **Reply**, validate
- Follow instructions from step 7 page 31 (Send SMS from the phonebook)

**Bobby**  
 Reply  
 □□□□□□□

### To forward an SMS

- 1- Go to **SMS**, validate
  - 2- Scroll to **Read SMS**, validate
  - 3- Choose your SMS box & enter the password (if you created several SMS boxes), validate
  - 4- Select the SMS from the list
  - 5- Scroll to **Forward**, validate
  - 6- Dial the number, validate
- Follow the instructions from step 7 page 13 (Send SMS to a phone)

**Bobby**  
 Forward  
 □□□□□□□



### To copy a number to the phonebook

- 1- Go to **SMS**, validate
- 2- Scroll to **Read SMS**, validate
- 3- Choose your SMS box & enter the password (if you have created several SMS boxes), validate
- 4- Select the SMS from the list
- 5- Scroll to **Copy to phonebook**, validate
- 6- Enter the name, validate
- 7- The number is automatically stored

Bobby  
Copy to phonebook  
□□□□□□●□

### To call from the SMS list

- 1- Go to **SMS**, validate
- 2- Scroll to **Read SMS**, validate
- 3- Choose your SMS box & enter the password (if you have created several SMS boxes), validate
- 4- Select the SMS from the list, validate
- 5- Scroll to **Call** or connect the line 

Bobby  
Call  
□□□□□□□●

Options are commonly available for both SMS sent from a phone and an E-mail.  
These options are **View SMS**, **View number**, **Send again** and **Delete SMS**.

### To read an SMS stored in the SMS list

- 1- Go to **SMS**, validate
- 2- Scroll to **Read SMS**, validate
- 3- Choose your SMS box & enter the password (if you have created several SMS boxes), validate
- 4- Select the SMS from the list, validate
- 5- Select **View SMS** and validate

Bobby  
View SMS  
●□□□□□□□

### To view the number

- 1- Go to **SMS**, validate
- 2- Scroll to **Read SMS**, validate
- 3- Choose your SMS box & enter the password (if you have created several SMS boxes), validate
- 4- Select the SMS from the list, validate
- 5- Scroll to **View number**, validate and read the information

Bobby  
View number  
□●□□□□□□

### To re-send an SMS

- 1- Go to **SMS**, validate
- 2- Scroll to **Read SMS**, validate
- 3- Choose your SMS box & enter the password (if you have created several SMS boxes), validate
- 4- Select the SMS from the list, validate
- 5- Select **Send again**, validate  
Follow instructions on the display

Bobby  
Send again  
□□□□●□□□



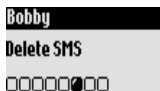

### To delete an SMS

- 1- Go to **SMS**, validate
- 2- Scroll to **Read SMS**, validate
- 3- Choose your SMS box & enter the password (if you have created several SMS boxes), validate
- 4- Select the SMS from the list, validate
- 5- Select **Delete SMS** and validate

## SMS settings

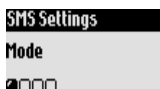

### To set the SMS mode

If there are two SMS-enabled phones on your telephone line, you will have to deactivate the SMS feature on 1 of the devices.

- 1- Go to **SMS**, validate
- 2- Scroll to **SMS Settings**, validate
- 3- Scroll to **SMS mode**, validate
- 4- Choose **ON/OFF** and validate



### To set your personal SMS box (country dependent)

Create your personal SMS box and give its number to your correspondents so that they send the SMS to your own SMS box.

- 1- Go to **SMS**, validate
- 2- Scroll to **SMS Settings**, validate
- 3- Scroll to **SMS box**, validate
- 4- Scroll to **Add new**, validate
- 5- Enter the box number (between 1 & 9), validate
- 6- Enter the password twice, validate (password not compulsory)

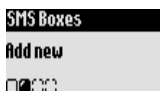

To change the password, Select an SMS box and choose **Change password**. If you forget your password, delete the corresponding box. Choose **Delete**, confirm your choice and validate.

**Warning** : When an SMS box is deleted, so are the attached SMS.

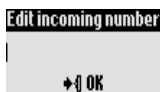

### To set the SMS centre number(s)

The SMS are sent through a centre. Your Onis 380 Vox is preset for optimum use, we advise you not to change the settings and read carefully the red leaflet provided in the box.

- 1- Enter **incoming number**, validate
- 2- Enter **Outgoing number**, validate
- 3- Enter the **E-mail server number** and **E-mail separator** (Country dependent)





### SMS Settings

#### Validity period



### To set the validity period (country dependent)

You can set the SMS to be valid for a certain period of time

- 1- Go to **SMS**, validate
- 2- Scroll to **SMS Settings**, validate
- 3- Scroll to **Validity period**, validate
- 4- Choose the appropriate period and validate



 **Handset**

- Sounds
- Babysit mode
- Registration
- Rename handset
- Languages
- Date & time
- Display contrast
- Backlight

**Navigation reminder :**

- +> (Go to) > (Validate)
- << (Scroll to) <<> (Select)

## Setting the handset sounds

You can set the ringer for :

- The external standard ringer for callers whose number is not stored in the phonebook or with no VIP settings (see page 30).
- The internal ringer for intercom (if there are at least 2 handsets).

To set the 3 VIP ringer types (Friends 😊, Family 👤 & Work 🏢 ) see page 36.

**Sounds**

Ringer type

●○○○○

### To set the ringer on the handset

- 1- Go to **Handset**, validate
- 2- Select **Sounds**, validate
- 3- Select **Ringer type**, validate
- 4- Choose **External Standard ringer/Internal ringer**, validate
- 5- Select the ringer in the list and validate

**Sounds**

Ringer volume

○○○○○

### To set the volume level

There are 5 levels plus the vibration call alert.

- 1- Go to **Handset**, validate
- 2- Select **Sounds**, validate
- 3- Scroll to **Ringer volume**, validate (the current level is heard)
- 4- Choose the appropriate volume and validate

**Note:** You can also activate the vibration call alert. In this case, the ringer will be in silence mode

**Sounds**

Earpiece tone

○○○○○

### To set the earpiece tone

- 1- Go to **Handset**, validate
- 2- Select **Sounds**, validate
- 3- Scroll to **Earpiece tone**, validate
- 4- Choose **Standard, Treble** or **Bass** and validate

**Sounds**

Key & feedback tones

○○○○○

### To set the key & feedback tones

Tones are audio feedbacks heard when pressing the keys, validating a setting.

- 1- Go to **Handset**, validate
- 2- Select **Sounds**, validate
- 3- Scroll to **Key & feedback tones**, validate
- 4- Select **ON/OFF**, validate



### To set the notification beep

The notification beeps are audio indicators heard when there is a new SMS or a message on the voice mailbox.

- 1- Go to **Handset**, validate
- 2- Select **Sounds**, validate
- 3- Scroll to **Notification beep**, validate
- 4- Select **ON/OFF**, validate

## The babysit mode

This feature allows you to monitor the baby's room. Place the handset in the room to be monitored and you will hear the noise coming from the room on the additional handset.



### To activate/deactivate the babysit mode

- 1- Go to **Handset**, validate
- 2- Scroll to **Babysit mode**, validate
- 3- Select **ON/OFF**, validate

An Intercom is necessary to monitor the room (see page 27).

Note : You can still answer a call or make a call with the handset.

**Warning :** If, when a handset is in babysit mode ON, if another handset transfers a call, then the former automatically answers the internal call.

## Registration

Up to 8 handsets can be registered to the base station. 1 handset can be associated to 4 base stations.

**Warning :** If you wish to associate non Philips handsets to the Onis 380 Vox base station, make sure that this handset is GAP compliant otherwise it will not operate properly (See page 41).



### To register an additional handset

- 1- Unplug and plug back in the mains lead to put the base into registration mode
- 2- With the additional handset, press **➡** to start the registration
- 3- Enter the 4-digit RC code written on the sticker placed under the base station.
- 4- Validate **➡**

If successful, the additional handset will be named & numbered (**Philips2**). The attached digit is linked to the registration order.



### To un-register the handset

- 1-Go to **Handset**, validate
- 2- Scroll to **Registration**, validate
- 3- Select **Un-register handset**, validate
- 4- Choose in the list the handset to un-register, validate
- 5- Enter the RC code (4-digit code) and validate

Note : If you can, un-register a defective handset before returning the product to the repair centre.



## Using the Onis 380 Vox handset with several base stations (Philips or non-Philips)

Each Onis 380 Vox handset can be used with up to 4 base stations. To use a handset with another base station, the handset must first be registered to that base station (see page 19).



When you want to call through that base station

- 1- Go to **Handset**, validate
  - 2- Scroll to **Registration**, validate
  - 3- Scroll to **Base selection**, validate
- Choose the base from the list and validate.

**Warning :** The handset will automatically operate with the last base station to which it was registered. If the handset is out of range, it will automatically search for another base station from the list.

## Renaming the handset



**To rename a handset**

- 1- Go to **Handset**, validate
- 2- Scroll to **Rename handset**, validate
- 3- Change the name and validate

## Changing the language



**To change the language**

- 1- Go to **Handset**, validate
- 2- Scroll to **Language**, validate
- 3- Select the language and validate

**Warning :** Changing the language will not change the voice prompts of the answer machine.

## Setting the date and time

This feature sets the system to the right date & time.

It is also used to date the messages and all events in the call log.



**To set the date**

- 1- Go to **Handset**, validate
- 2- Scroll to **Date & time**, validate
- 3- Choose **Set date**, validate
- 4- Enter the current date and validate





### To set the time

- 1- Go to **Handset**, validate
- 2- Scroll to **Date & time**, validate
- 3- Choose **Set time**, validate
- 4-Enter the current time and validate

**Warning** : If your phone is connected to an ISDN line through an adapter the date & time may change after each call. Please check the date & time settings in the ISDN system. Please contact your network provider.

## Setting the display contrast



### To set the contrast

- 1- Go to **Handset**, validate
- 2- Scroll to **Display contrast**, validate
- 3- Select the appropriate level and validate

## Setting the backlight

Both display and keypad are backlit.



### To set the backlight

- 1- Go to **Handset**, validate
- 2- Scroll to **Backlight**, validate
- 3- Select **10s / 20s / OFF** and validate

Note : Deactivating the backlight saves battery life.



 **Answer machine**

- Saved messages
- Record memo
- Out going message
- TAM Settings

**Navigation reminder :**

- +1<img alt="arrow right icon" data-bbox="705 125 725 145"/><img alt="arrow left icon" data-bbox="705 125 725 145"/> (Go to) +1<img alt="arrow right icon" data-bbox="805 125 825 145"/> (Validate)
- <img alt="arrow left icon" data-bbox="685 155 705 175"/><img alt="arrow right icon" data-bbox="705 155 725 175"/> (Scroll to) <img alt="arrow left icon" data-bbox="805 155 825 175"/><img alt="arrow right icon" data-bbox="825 155 845 175"/> (Select)

## Using the answer machine

### Setting the answer machine

Set the answer machine to allow callers to leave messages.

You can access the answer machine either from the base station or the handset.

By default the answer machine is activated. It can store up to 30 messages within the maximum recording time of 60 mins. A message can be up to 3 mins long.

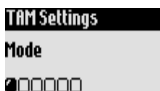
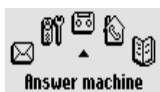

#### To switch the Telephone Answer Machine (TAM) ON/OFF

From the handset

- 1- Go to **Answer machine**, validate
- 2- Scroll to **TAM Settings**, validate
- 3- Select **ON/OFF**

From the base station press  or  to activate/deactivate the answer machine (See page 8)

### Listening to your messages

You can listen to new or saved messages via the handset or the base station.

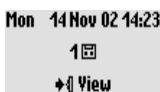

#### To listen to the new message(s) via the handset

The display shows there is 1 new message (1 )

- 1- Press <img alt="arrow right icon" data-bbox="375 635 395 655"/> to **View**
- 2- The message is automatically played

Note : If you have subscribed to the Caller Display service (CLI), the display shows the name or number of the caller and its VIP group if activated (see page 30).

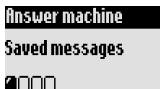

#### To listen to saved messages via the handset

- 1- Go to **Answer machine**, validate
- 2- Select **Saved messages**, validate
- 3- Select the message to listen, validate
- 4- Choose **Play** in the options and validate

Note : you can listen to message(s) via the Call log. A long press on  accesses the messages list, the entry is marked <img alt="arrow right icon" data-bbox="735 875 755 895"/><img alt="message icon" data-bbox="755 875 775 895"/> (see page 32).

**To listen to new /saved message(s) via the base station** Press  .



## Deleting messages

Paula Jameson  
Delete  
□□□□□□

### To delete messages

Once you have listened to the message you can delete it.

- 1- Go to **Answer machine**, validate
- 2- Select **Saved messages**, validate
- 3- Select the message to delete, validate
- 4- Scroll to **Delete**, validate

**Warning :** If **Answerphone full** message appears on the handset display, there is no more space for messages. Delete messages so that new ones can be left.

## Selecting the answer mode and the outgoing message type

You can select among 2 answer modes : Answer only (when no messages can be left), and Answer & Record (when messages can be left). For each mode, 2 outgoing message types are available : Predefined or Personal message. By default the answer machine is set to Predefined Answer & Record mode.

Answer machine  
Outgoing Messages  
□□□□

### To select the answer mode

- 1- Go to **Answer machine**, validate
  - 2- Scroll to **Outgoing messages**, validate
  - 3- Select **answ. machine mode**, validate
  - 4- Choose the appropriate mode (among the 4 options above) and validate
- Note : A predefined message cannot be deleted.

## Recording your personal outgoing message (OGM)

You can record 5 different personal OGM :

- a specific personal OGM for Answer & Record mode for each of the VIP phonebooks (Family, Friends, Work),
- the standard OGM for Answer & Record mode for non VIP callers, and
- the standard OGM for Answer only mode for all callers.

It is possible to record specific messages for VIP groups only if you subscribe to the Caller Display service (CLI) and if you have set the VIP groups in the phonebook (See page 30).

### To record an outgoing message

- 1- Go to **Answer machine**, validate
- 2- Scroll to **Outgoing messages**, validate
- 3- Scroll to **Record Outgg mssg**, validate
- 4- Select a group (standard or 1 of the 3 VIP groups), validate
- 5- Select **Record new**, validate
- 6- Press **↔** to start recording

To stop recording press **↔** again

The message is automatically played back. You can delete and/or record it again. The personal message can be up to 3 mins long.

Note : Select a standard outgoing message (OGM) if you have no Caller Display (CLI) subscription.

Answer machine  
Outgoing Messages  
□□□□

Outgoing Messages  
Record outgg mssg  
□□

Record outgg mssg  
Family  
□□□□

Family  
Record new  
□□□

Record outgg mssg  
Press the Pilot-key  
to record  
↔ Start

Record outgg mssg  
Recording...  
↔ Stop





## Setting the number of rings before answer

You can set the answer machine to start playing the outgoing message after a given number of rings (3,5,7 and Toll saver).

The toll saver option (activated by default) is useful when using the remote access. The answer machine will start playing the outgoing message after 3 rings if there are new messages. If there is no new message the outgoing message will be played after 5 rings.

Hang up after the 4th ring if you want to check if you have any messages at no cost.

**TAM Settings**  
Number of rings  
before answering  
000000

### To set the number of rings before answer

- 1- Go to **Answer machine**, validate
- 2- Scroll to **TAM Settings**, validate
- 3- Scroll to **Number of rings before answering**, validate
- 4- Select the appropriate setting and validate

## Setting the voice prompts

Voice prompts are vocal indications played when consulting the answer machine. By default they are activated. You can set them to indicate the number & date of the messages or the number of messages only. You can also deactivate them.

**TAM Settings**  
Voice prompts  
000000

### To set the voice prompts

- 1- Go to **Answer machine**, validate
- 2- Scroll to **TAM Settings**, validate
- 3- Scroll to **Voice prompts**, validate
- 4- Select **Messages & date/Messages/OFF** and validate

## Setting the call screening

This feature allows you to set the volume of the base station loudspeaker so that you can choose whether or not to hear the callers leaving a message.

**TAM Settings**  
Call screening  
000000

You can set permanent call screening on the base station

### To activate/deactivate the call screening

- 1- Go to **Answer machine**, validate
- 2- Scroll to **TAM Settings**, validate
- 3- Scroll to **Call screening**, validate
- 4- Select **ON/OFF** and validate

Call screening “call by call” on the base is possible even if the call screening is deactivated it can be switched on at any time when somebody leaves you a messages. Press  on the base each time necessary.



To increase the volume of the base loudspeaker when on line, press (+) several times.

To decrease and/or deactivate the base loudspeaker when on line, press (-) several times.

## Setting the recording quality

There are 2 recording qualities : standard & high.

In standard quality the total capacity is up to 60 mins. In high quality the total capacity is up to 30 mins.



### To set the recording quality

- 1- Go to **Answer machine**, validate
- 2- Scroll to **TAM Settings**, validate
- 3- Scroll to **Recording quality**, validate
- 4- Select the appropriate settings and validate

## Activating the remote control



### To activate/deactivate the remote control feature

- 1- Go to **Answer machine**, validate
- 2- Scroll to **TAM Settings**, validate
- 3- Scroll to **Remote control**, validate
- 4- Scroll to **Mode**, validate
- 5- Select **ON/OFF** and validate

Note : The default setting is OFF. Activate this feature if you want to be able to remotely use the answer machine.

## Remotely control your answer machine

To remotely access your answer machine :

- 1- From another phone, dial your home phone number
- 2- During or after the message press the star key (\*) on the phone
- 3- Dial your remote control code
- 4- If you have new messages they will be automatically played.

The following table indicates the features available when remotely accessing the answer machine.

Record memo :	Dial (0)
Play previous message :	Dial (1)
Play message :	Dial (2)
Play next message :	Dial (3)
Listen again to the message :	Dial (5)

Delete :	Dial (6)
Activate answer machine :	Dial (7)
Stop :	Dial (8)
Deactivate answer machine :	Dial (9)



**Remote control**  
Change code  
□□

**Enter remote c. code:**  
8963  
➔ OK

### To change the remote control code

The default code is 0000. We advise you to personalise it.

- 1- Go to **Answer machine**, validate
- 2- Scroll to **TAM Settings**, validate
- 3- Scroll to **Remote control**, validate
- 4- Scroll to **Change code**, validate
- 5- Enter the new remote c. code and validate

**Warning :** The Remote Control code is not the Registration Code (RC).

## Recording/listening to a local message on the handset

This feature allows you to leave local messages for your family on the answer machine.

A memo is recorded from the handset, it is represented by  in the call log and can last up to 3 mins.

**Answer machine**  
Record a memo  
□□□□

**Record a memo**  
Press the Pilot-key  
to record  
➔ Start

Mon 14 Nov 02 14:23  
1   
➔ View

**Saved messages**  
Play  
□□□□□□

### To record a memo on the handset

- 1- Go to **Answer machine**, validate
- 2- Scroll to **Record a memo**, validate
- 3- Press **➔** to start recording
- 4- Press again to stop

### To listen to the memo on the handset

The display shows there is 1 new local message (1 )

- 1- Press **➔** to **View**
- 2- The message is automatically played

**Delete** is also available in the options

### To listen to a saved memo on the handset

- 1- Go to **Answer machine**, validate
- 2- Select **Saved messages**, validate
- 3- Select **Play**, validate.

Long press on  to reach the messages list.



 **Intercom**  
 Call all  
 Handset list

**Navigation reminder :**  
 +\*# (Go to) #\*# (Validate)  
 \*#\* (Scroll to) #\*# (Select)

## Using the intercom (if there are at least 2 handsets)

This feature allows you to make internal calls, use the babysit (room monitoring), transfer external calls from one handset to the other or use the conference call option.

The intercom is possible with handsets registered to the same base station.

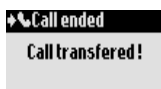
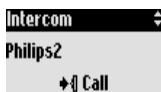
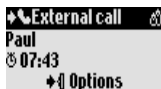
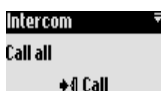

### Internal call or babysit mode activation

- 1- Go to **Intercom**, validate
- 2- If there is only one additional handset, it rings automatically. Otherwise, select from the list the handset you want to call, validate
- 3- The called handset rings

- 4- Take the line  on the called handset.

The intercom conversation/babysit mode can start.

**Mute** is also available.

Note :You can also access the Intercom via the pilot key. In idle mode scroll up 

### Call transfer from the handset

During an external call you can transfer the call to another handset via the Intercom option available in the in-call options.

- 1- press +\*#
- 2- Scroll to **Intercom**, validate
- 3- If there is only one additional handset, it rings automatically. Otherwise, select from the list the handset you want to call and +\*# **Call**

The called handset rings. The external call is put on hold.

If there is no answer from the second handset you can resume the call on the first handset, use the **End Intercom** option.

- 4- Take the call  on the other handset

Both internal callers can talk.

- 5- Use the **Transfer** option in the menu.

The call is ended on the first handset. The display gives the feedback.

Note :You can also stop the call on the first handset with .

When the call is put on hold the caller hears music (if music on hold is activated) or beeps (See page 38).



**Options**  
**Conference call**  
□□□□

### **Conference call**

Conference call allows one external call to be shared with 2 handsets (in Intercom). All 3 people can share the conversation. No operator subscription is needed.

- 1- Press **↔**
- 2- Scroll to **Intercom**, validate
- 3- Select from the list the handset you want to call and **↔ Call**
- 4- Take the call **☎** on the other handset
- 5- Use the **Conference call** option, validate









### Phonebook

View  
Add new

**Navigation reminder :**



  (Go to)  (Validate)  
 (Scroll to)  (Select)

## Using the phonebook

Two hundred names and numbers can be stored in the phonebook.

The phonebook contains all the information related to the callers, especially the VIP settings. The names & numbers are shared with all the handsets registered to your base.

### VIP settings

The VIP groups are Friends , Family  and Work . When ringing, the VIP ringer helps you identify the caller's group and the screen shows the caller's name. A specific welcome message can be associated to a VIP group (see page 23). A subscription to the Caller Display (CLI) service is needed.

## Adding a name to the phonebook



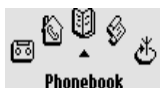

The names are stored in alphabetical order.

### To store a name

- 1- Go to **Phonebook**, validate
- 2- Scroll to **Add new**, validate
- 3- Dial the number, validate
- 4- Enter the name, validate (see page 12)



A long press on  gives direct access to **Enter number**.

<b>Phonebook</b>	<b>Enter number :</b>	<b>Enter name :</b>  	<b>Enter name :</b>  	<b>Stored!</b>
Add new			Gregory Mills	
	+ OK	+ OK	+ OK	

### To store a name from predial

Once the number is dialled, select **Store** in the options

## Calling from the phonebook

Phonebook 

Paula Jameson  
014184098765...

+ Options

### To call from the phonebook

- 1- Go to **Phonebook**, validate
- 2- Scroll to **View**, validate
- 3- Select a name from the list
- 4- Choose **Call** in the options or press 



## Viewing the phonebook

You can browse the phonebook and make some changes. To quickly reach the phonebook press . To quickly reach a name in the list, enter the first character (choose from the list if several names start with the same letter). Make the call .

### To view the phonebook

- 1- Press .
- 2- Browse the list and select a name, validate

### To change a number

- 1- Go to **Phonebook**, validate
- 2- Scroll to **View**, validate
- 3- Select a name from the list, validate
- 4- Scroll to **Change number**, validate
- 5- Enter the new number and validate



Note : It is possible to erase the current number with . You can simply change a digit, move the cursor to reach a particular place.

### To change a name

- 1- Go to **Phonebook**, validate
- 2- Scroll to **View**, validate
- 3- Select a name from the list, validate
- 4- Scroll to **Change name**, validate
- 5- Enter the new name and validate



Note : It is possible to erase the current name with . You can simply change a character, move the cursor to reach a particular place.

### To define VIP group

To benefit from the VIP feature, you must store the entry in a VIP group.

- 1- Go to **Phonebook**, validate
- 2- Scroll to **View**, validate
- 3- Select a name from the list, validate
- 4- Scroll to **Define the VIP group**, validate
- 5- Select the VIP group and validate



### To set an SMS box number to a name

If you know the receiver's personal SMS box, associate the destination box with his name, you will not need to enter it when sending him an SMS.

- 1- Go to **Phonebook**, validate
- 2- Scroll to **View**, validate
- 3- Select a name from the list, validate
- 4- Select **Change SMS box**, validate
- 5- Enter the destination box number, validate





### To delete a name

- 1- Go to **Phonebook**, validate
- 2- Scroll to **View**, validate
- 3- Select a name from the list, validate
- 4- Choose **Delete** and validate



### To send an SMS from the phonebook

- 1- Go to **Phonebook**, validate
- 2- Scroll to **View**, validate
- 3- Select a name from the list, validate
- 4- Scroll to **Send SMS**, validate
- 5- Choose your SMS box & enter the password (if you created several SMS boxes), validate
- 6- Enter the destination box (if prompted to), validate
- 7- Select **New SMS/SMS list**, validate
- 8- Write the text (p 12) or choose from the list, validate
- 9- Scroll to **Delivery report**, validate
- 10- Select **Send Now**, validate





 **Call log**

- View
- Delete all
- Call log Settings

**Navigation reminder :**

- +↔↔ (Go to) ↔ (Validate)
- ↔↔ (Scroll to) ↔↔ (Select)

# Using the call log

Use  to enter the call log. The call log stores up to 40 entries.

-  : unanswered calls
-  : answered calls
-  : messages
-  : outgoing calls
-  : local messages or recorded conversation
-  : messages (voice mailbox/if info sent by the network operator)

If you have subscribed to the Caller Display service (CLI), the call log shows, for incoming & outgoing calls, the name (or number) of the callers, the VIP group icon if any, the date & time of the call as well as the number of times they have tried to reach you (up to 9).

## Viewing the call log

### To view the call log from the handset

- 1- Press 
- 2- The list is displayed, scroll through the list to reach the desired information, validate

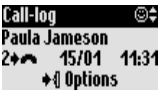

### To call/call back or redial from the call log

- 1- Go to **Call log**, validate
- 2- Scroll to **View**, validate
- 3- Scroll through the list to reach the desired entry, validate
- 4- Select **Call** in the options or press 



### To listen to a message from the call log

- 1- Go to **Call log**, validate
- 2- Scroll to **View**, validate
- 3- Scroll through the list to reach the desired entry, validate
- 4- Select **Play** and validate

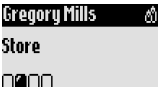

### To store the caller's name and phone number from the call log

- 1- Go to **Call log**, validate
- 2- Scroll to **View**, validate
- 3- Scroll through the list to reach the desired entry, validate
- 4- Select **Store**, validate
- 5- Enter the name, validate



### To delete an entry from the call log

- 1- Go to **Call log**, validate
- 2- Scroll to **View**, validate
- 3- Scroll through the list to reach the desired entry, validate
- 4- Select **Delete**, validate
- 5- Confirm your choice and validate

**Warning :** If a message is associated with the entry it is also erased from the answer machine.



### To send an SMS from the call log

- 1- Go to **Call log**, validate
- 2- Scroll to **View**, validate
- 3- Scroll through the list to reach the desired entry, validate
- 4- Scroll to **Send SMS**, validate
- 5- Choose your SMS box & enter the password (if you have created several SMS boxes) validate
- 6- Enter the destination box (if prompted to), validate
- 7- Select **New SMS/SMS list**, validate
- 8- Write the text (p 12) or choose from the list, validate
- 9- Scroll to **Delivery report**, validate
- 10- Select **Send Now**, validate

## Deleting all the call log

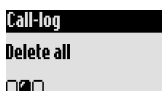

### To delete all the call log

You can choose to delete all the call log at once.

- 1- Go to **Call log**, validate
- 2- Scroll to **Delete all**, validate
- 3- Confirm your choice and validate

Note :The entries with unread messages will not be deleted.

## Setting the call log

You can set the call log to store information about incoming calls &/or outgoing calls.



### To set the call log

- 1- Go to **Call log**, validate
- 2- Scroll to **Call-log Settings**, validate
- 3- Select **Incoming calls/ Outgoing calls**, validate
- 4- Select the appropriate setting and validate.



 **Network**  
 “Cheapest rates” Fct  
 Operator services

**Navigation reminder :**  
 +↵↵ (Go to) ↵ (Validate)  
 ↵ (Scroll to) ↵↵ (Select)

## Using the cheapest rates function

This feature allows you to set the phone to use the cheapest operator prefix (if you are subscribed to several).

You must set the operator prefix, the period of time, the countries or the other party’s phone type (mobile or landline). Several additional steps are needed to call with this feature.

### To set the cheapest rates prefix

- 1- Go to **Network**, validate
  - 2- Select **Cheapest rates Fct**, validate
  - 3- Scroll to the appropriate item (night, day, weekend, mobile or country), validate
  - 4- Scroll to **Change name** and enter the operator’s name, validate
  - 5- Scroll to **Change number** and enter the operator prefix according to the previously selected item, validate
- Note : If you select “night” or “day” you will be prompted to also set the start time.



**Network**  
 Cheapest Rates Fct  
 ☐

**Day**  
 Change number  
 ☐☐☐

### To call with the cheapest operator rates

The cheapest rates feature is used call by call. The information stored previously allows the appropriate prefix to be suggested when calling with the cheapest rates feature.

### To call with the cheapest rates

- 1- Go to **Network**, validate
  - 2- Select **Cheapest rates Fct**, validate
  - 3- The cheapest operator prefix is displayed according to the Timer. If you want to use the cheapest operator for mobile, scroll to the corresponding item. Validate twice. You are then in predial mode.
  - 4- Press , scroll through the list to reach the name in the phonebook and validate to chain dial (or dial see page 10)
  - 5- Connect the line 
- Note : You can also access the cheapest rates with the pilot key. In idle mode scroll down , resume from step 4 above.

**Network**  
 Cheapest Rates Fct  
 ☐

**Cheapest Rates Fct** ▾  
 Day  
 +↵ Options

**Day**  
 Use prefix  
 ☐☐☐

**Predial :**  
 977  
 +↵ Options



**Phonebook** ▾  
 Baker Adam  
 0245849637  
 +↵ OK

**Predial :**  
 9970245849637  
 +↵ Options



**Calling**  
 9770245849637  
 0.02  
 +↵ Options



## Using the operator services (Subscription dependent)

This feature allows you to activate or deactivate the operator services.

Codes need to be set up (see page 40).

Contact your network operator for more details. You can usually subscribe to Call forward, operator Voice mail box etc...

### Example of service : Call forward

Calls can be redirected to another phone number.

Set the code (see page 40 ) and activate it when necessary.



### To activate/deactivate call forward

- 1- Go to **Network**, validate
- 2- Scroll to **Operator Services**, validate
- 3- Select **Call forward**, validate
- 4- Dial (or choose from phonebook) the number to which the calls are to be forwarded and validate
- 5- The number is automatically chained to the call forward prefix and the system dials the number
- 6- Hang up (📞)

From now on your calls will be redirected to the assigned phone number. The display shows the information.

To stop call forward, deactivate it via the **Cancel call forward** option.



### Extra

VIP melody function  
Call cost & duration  
Alarm clock  
“Do Not Disturb” mode

### Navigation reminder :

+>|<|> (Go to) +>|<|> (Validate)  
<|>|<|> (Scroll to) <|>|<|> (Select)

## VIP melodies

Subscription to the Caller Display (CLI) service is needed.

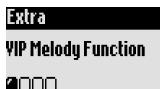

### To set the VIP ringers

- 1- Go to **Extra**, validate
- 2- Select **VIP melody function**, validate
- 3- Select a group, validate
- 4- Choose a melody and validate

Note :The VIP ringer is heard on both the base and the handset.

## Call cost and duration (Country and subscription dependent)

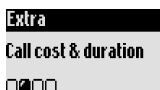

### To view the call cost & time

- 1- Go to **Extra**, validate
  - 2- Scroll to **Call cost & duration**, validate
  - 3- Select **View total**, validate
- The total cost & time of communications is displayed
- 4- Press +>|<|> to **Reset** the counter



To allow the phone to calculate the cost of a call you must enter the price per unit

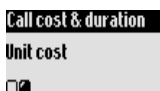

- 1- Go to **Extra**, validate
- 2- Scroll to **Call cost & duration**, validate
- 3- Scroll to **Unit cost**, validate
- 4- Enter the cost and validate

## The alarm clock

### To activate/deactivate the alarm clock

A long press on  activates/deactivates the alarm clock with your own settings.



### To set the alarm clock

- 1- Go to **Extra**, validate
- 2- Scroll to **Alarm clock**, validate
- 3- Select **Set day** and select a day, validate
- 4- Scroll to **Set time** and enter the time, validate

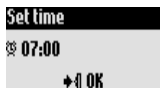

When the alarm rings, press any key to stop it.

The snooze is then activated (will ring again every 5 mn).

To definitely stop it press +>|<|>.



### To set the alarm ringer type

- 1- Go to **Extra**, validate
- 2- Scroll to **Alarm clock**, validate
- 3- Select **Alarm clock Settings**, validate
- 4- Select **Ringer type**, validate
- 5- Choose among the available ringer types and validate

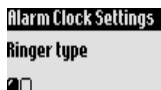

### To set the alarm ringer volume

- 1- Go to **Extra**, validate
- 2- Scroll to **Alarm clock**, validate
- 3- Select **Alarm clock Settings**, validate
- 4- Select **Ringer volume**, validate
- 5- Choose among the available volume levels and validate



## “Do Not Disturb” mode

This feature allows you to screen the calls after a certain time in the evening or when you do not wish to be disturbed. Enter the time and select the VIP group allowed to call you.

If the caller does not belong to an allowed group, the handset & base station will remain silent, while he will hear ringing. The green indicator informs you of an incoming call. The answer machine (if activated) or the operator voice mailbox will answer the call.

Suscription to the Caller Display (CLI) service is needed.

By default the feature is OFF.

### To activate/deactivate the Do Not Disturb mode from the handset

A long press on  activates/deactivates this mode with your own settings.

### To activate/deactivate “Do Not Disturb” mode

- 1- Go to **Extra**, validate
- 2- Scroll to **Do Not Disturb mode**, validate
- 3- Select **Set day** and select a day, validate
- 4- Scroll to **Start time** and enter the time, validate
- 5- Scroll to **Stop time** and enter the time, validate
- 6- Scroll to **Allowed caller choice**, activate the callers group allowed to call you and validate

Note :You can select up to 4 groups. If no group is selected but the feature is activated, then nobody will be able to reach you.

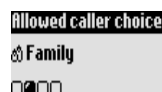
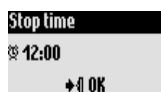
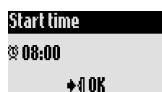
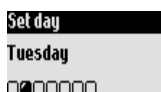
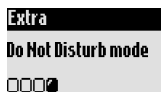



 **Base station**

- Sounds
- Registration
- Line settings
- Service code settings

**Navigation reminder :**

- +↔↔ (Go to) ↔ (Validate)
- ↔↔ (Scroll to) ↔↔ (Select)

# Setting the base station

## Setting the base station sounds



- To set the ringer type**
- 1- Go to **Base station**, validate
  - 2- Scroll to **Sounds**, validate
  - 3- Select **Ringer type**, validate
  - 4- Choose the ringer in the list and validate

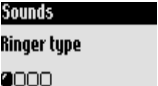

- To record the personal melody**
- 1- Go to **Base station**, validate
  - 2- Scroll to **Sounds**, validate
  - 3- Scroll to **Record pers melody**, validate
  - 4- Scroll to **Record new melody**, validate
  - 5-  to start recording
  - 6- Press again to stop recording
  - 7- Activate this ringer in the above menu



- To set the ringer volume level**
- 1- Go to **Base station**, validate
  - 2- Scroll to **Sounds**, validate
  - 3- Scroll to **Ringer volume**, validate
  - 4- Select the appropriate level and validate



- To activate/deactivate the music on hold**
- The feature allows the caller to hear music when the call is put on hold when transferring a call.
- 1- Go to **Base station**, validate
  - 2- Scroll to **Sounds**, validate
  - 3- Select **Music on hold**, validate
  - 4- Select **ON/OFF**, validate
- Note : If the feature is deactivated, the caller will hear beeps.





## Registration

This feature allows you to register a DECT peripheral without keypad

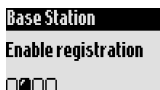

### To register a DECT peripheral

- 1- Go to **Base station**, validate
- 2- Scroll to **Enable registration**, validate
- 3- Enter the peripheral code and validate
- 4- Follow instructions in the peripheral manual (see page 41)

## The line settings

It can be useful to change the line settings if your network operator is not the main national operator set by default in the phone, especially for the Caller Display service (CLI).



### To change the dial mode (country dependent)

- 1- Go to **Base station**, validate
- 2- Scroll to **Line settings**, validate
- 3- Select **Dial mode**, validate
- 4- Select **Tone/Pulse**, validate

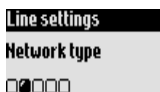

### To change the network type

- 1- Go to **Base station**, validate
- 2- Scroll to **Line settings**, validate
- 3- Scroll to **Network type**, validate
- 4- Select **PSTN/PABX**, validate

Philips has designed this product to work on PSTN line and cannot guarantee the complete application on ISDN network.



### To change the recall type (country dependent)

- 1- Go to **Base station**, validate
- 2- Scroll to **Line settings**, validate
- 3- Scroll to **Recall type**, validate
- 4- Select **Short flash/Long flash**, validate

Note : This feature is useful when you are using operator services, with the

 key.





### To change the operator type (country dependent)

- 1- Go to **Base station**, validate
- 2- Scroll to **Line settings**, validate
- 3- Scroll to **Operator type**, validate
- 4- Select among the suggested types and validate

Note : Useful if the Caller Display service does not work when you subscribed to that service. The default setting is type 1.



### To activate/deactivate the first ring

To prevent the phone from ringing when receiving an SMS, the first ringer is deactivated. You can activate it.

- 1- Go to **Base station**, validate
- 2- Scroll to **Line settings**, validate
- 3- Scroll to **First ring**, validate
- 4- Select **ON/OFF**, validate

## Service code settings

When you subscribe to extra services with your operator you may need to set some codes in your phone.

The default codes are the codes used by the main national network operator.

If you subscribed to another operator you may need to change the codes.

Contact your network operator for more information on the services (see page 35).



### To change a service code

- 1- Go to **Base station**, validate
- 2- Scroll to **Service code settings**, validate
- 3- Select the appropriate service, validate
- 4- Select **Change** and enter the new code and validate

## Using GAP standard compliance

The GAP standard guarantees that all DECT™GAP handsets and base stations comply with a minimum operating standard irrespective of their make. Your Onis 380 Vox handset and base station are GAP compliant, which means the minimum guaranteed functions are : register a handset, take the line, receive a call and dial. The advanced features may not be available if you decide to use a handset other than the Onis 380 Vox with your base station.

To register and use your Onis 380 Vox handset with a GAP standard base station of a different make, first follow the procedure described in the manufacturer's instructions, then follow the procedure page 19.

To register a handset from another make to the Onis 380 base station, put the base station into registration mode (page 39), then follow the procedure in the manufacturer's instructions.

## Register a DECT™ peripheral without keypad

Some DECT™peripherals, such as repeaters, do not have a keypad. A special menu-operated procedure is used to register such peripherals with the base station without the need to disconnect the base station.

See page 19 or 39 to put the base station in registration mode, enter the code that comes with the peripheral and validate. Use the peripheral instructions to register it to the base station.

## Conformity, Environment and Safety

**Safety information** : This equipment is not designed to make emergency calls when the power fails. An alternative has to be made available to allow emergency calls.

**Conformity** : Hereby, Philips declare that the products Onis 380 (TU5371, TU5372 & TU5370) are in compliance with the essential requirements and other relevant provisions of Directive 1999/5/EC. Should you need a copy of the original certificate, please contact the Philips customer care center. This product can only be connected to the analog telephone network in the area which is indicated on the label placed under the base station.

**Power requirements** : This product requires an electrical supply of 220-240 volts, alternating monophased power, excluding IT installations defined in standard EN 60-950.

**Warning !** The electrical network is classified as dangerous according to criteria in the standard EN 60-950. The only way to power down this product is to unplug the power supply from the electrical outlet. Ensure the electrical outlet is located close to the apparatus and is always easily accessible.

**Telephone connection** : The voltage on the network is classified as TNV-3 (Telecommunication Network Voltages, as defined in the standard EN 60-950).

**Safety precautions** : Do not allow the handset to come into contact with water. Do not open the handset or the base station. You could be exposed to high voltages. Do not allow the charging contacts or the battery to come into contact with conductive materials.

**Environmental care** : Please remember to observe the local regulations regarding the disposal of your packaging materials, exhausted batteries and old phone and where possible promote their recycling.

## Declaration of conformity

We,  
Philips Consumer Electronics  
DECT & Home Telephony  
Route d'Angers  
72081 Le Mans Cedex 9  
France

Declare that the products Onis 380 (TU5371, TU5372 & TU5370) are in compliance with the Annex III of the R&TTE-Directive 1999/5/EC and then with the following essential requirements :

Article 3.1.a (protection of the health & the safety of the user) : EN 60950 (2000)

Article 3.1.b : (protection requirements with respect to the electromagnetic compatibility) :  
ETSI EN 301 489-6 V1.1.1 (09/2000) & ETSI EN 301 489-1 V1.3.1 (09/2001)

Article 3.2 (effective use of the radio spectrum) EN 301 406 (2001)



The presumption of conformity with essential requirements regarding Council directive 1999/5/EC is ensured.

Date : 08/04/03



Vice President & General Manager. DECT & Home Telephony

## Telephone troubleshooting...

PROBLEMS	CAUSES	SOLUTIONS
The green indicator does not light up	The base station is not properly connected	Check mains power and connections
The  does not scroll when the handset is placed on the base	- Bad contact - Dirty contacts	- Move the handset slightly - Clean the contacts with a cloth moistened with alcohol
No dialling tone	- No power - You are too far from the base station	- Check connections - Move closer to the base station
No ringer	- The ringer is deactivated - The Do Not Disturb mode is ON	- Set the ringer (see page 18, 38) - Deactivate it
The  does not appear	- No mains power - The handset is too far from the base station	- Check connections - Move closer to the base station
Crackling on the line	- Handset too far from the base station - The base station is too close to electrical appliances, reinforced concrete walls or metal doorframes	- Move closer to the base station - Move the base station to find a better place (the higher the better)
The handset displays "failed" - when attempting to add another handset to the base station - When using a handset	- The procedure to add a handset has failed, try again - Maximum number of handsets has been reached - Base station is already busy with another handset	- Disconnect and connect the base station power supply. Follow the procedure to register a handset (page 19, 39) - Un-register a handset (page 19) - Wait until it is available
Noise interference on your radio or television	The Onis 380 Vox base station or mains power pack are too close to electrical appliances	Move the base station or power pack as far as possible
Caller Line Identification service (CLI) does not work	- Service not activated	- Check your subscription with network
No new SMS are received	SMS memory is full	Delete old SMS
No SMS can be sent/received	- The outgoing/Incoming SMSC numbers are not set or are wrong - The SMS box or destination box is wrong - SMS mode is OFF	- Contact your operator to get the correct SMSC's numbers - Check the information stored (page 16) - Change SMS mode (page 16)

## Answer machine troubleshooting...

PROBLEMS	CAUSES	SOLUTIONS
The answer machine does not record messages	- The memory is full - The answer only mode is activated - The Answer & record is not activated	- Delete messages - Select the Answer & record mode - Press 
The remote control access does not work	The remote control access is not activated	Activate the remote control access (page 25)
It is not possible to record an outgoing message	The memory is full	Delete messages
The Onis 380 Vox hangs up during remote access	- 3 failed attempts to send a code - duration is too long	- Enter the correct code - Manage the remote control quicker
The answer machine stops automatically	- The memory is full - Message exceeds 3 mn	- Play & delete messages - Messages must not exceed 3 mn

# Index

## A

Adding handset 19  
Adding a name 29  
Alarm clock 36  
Answering call 7, 10  
Answer machine settings 23

## B

Babysit mode 19, 27  
Base keys 4  
Base ringer 36, 38  
Base stations & indicators 4  
Batteries & battery life 3, 6

## C

Call forward 35  
Call log 32, 33  
Call transfer/conference call 32, 33  
Calling from call log 10, 32  
Chain dialling 10  
Changing entry (name & number) 29  
Changing VIP group 30  
Cheapest rates (Changing operator) 34  
Contrast 21  
Call cost & duration 36

## D

Date & time (Set and change) 20, 21  
Deactivating ringer 18  
Deleting entry 31  
Deleting messages (answer machine) 23  
Deleting messages (SMS) 16  
Destination box 13  
Dial mode 39  
Direct calling 7, 10  
Do Not Disturb mode 27

## E/F

Earpiece tone 18  
Earpiece volume 11  
Ending call 7, 10  
Entry type (VIP/Standard) 30  
External ringer type 18  
First ring 40

## G

GAP 41

## H

Handset keys 2  
Handset ringer 18

## I

Icons 3  
In-call features 7, 11  
Indicators (LEDs) 3, 4  
Installation 6  
Internal ringer type 18  
Intercom 27

## K

Key & feedback tones 18  
Keypad lock/unlock 2

## L

Language 20  
Line settings 39  
Listening to messages (Answer machine) 22  
Listening to pre-recorded outgoing messages 23

Local message (Memo) 7, 26

## M

Making calls 7, 10  
Message service (Operator voice mail) 32  
Music on hold 38  
Mute 4, 7, 11

## N

Name (Add, delete, change) 29, 30, 31  
Network services 35  
Notification beeps 19  
Number (Change) 30

## O

Operator type 40  
Outgoing message 23

## P

Pause 2  
PABX/PSTN 39  
Phonebook 29, 30, 31  
Predial 10  
Pulse 39

## R

Range 6  
Recall type 39  
Recording quality 25  
Recording conversation 4, 7, 11  
Recording local memo 4, 7, 26  
Recording personal melody 38  
Recording personal outgoing message 23  
Redial 4, 7, 10  
Registration mode 39  
Remote programming (Answer machine) 25  
Remote accessing answer machine 25  
Remote control code 26  
Rename handset 20  
Ringers 19, 36, 38  
Rings before answering (Answer machine) 24

## S

Screening calls 4, 8, 24, 25  
Service codes settings 40  
Silence 10  
SMS box 16  
SMS (Sending) 13  
SMS centre 16  
SMS (Reading) 14  
SMS mode 16  
SMS settings 16  
Sounds 18, 38

## S/T

Toll saver (Answer machine) 24  
Tone 39

## U

Unregistering handset 19

## V

Vibration call alert 18  
VIP settings 30, 36  
Voice prompts 24  
Volume (Ringers) 18, 38

© 2003

Philips Consumer Electronics

DECT & Home Telephony

All rights reserved

Printed in France

[www.philips.com](http://www.philips.com)

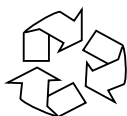

3111 285 20442

# INFORMATION ON TEXT MESSAGING (SMS) IN EIRE

You must first subscribe to your network provider's Caller Display service.

Example : call EIRCOM free 1901.

**WARNING !** Change the SMS centre in your Onis 300 :

Go to **SMS** menu and select **SMS Settings** sub menu.

Select the **SMS Centre** sub menu and choose **SMS Centre 3**.

Please refer to the Onis 300 user manual page 11.

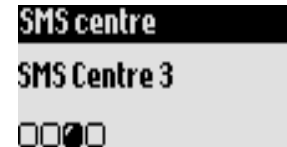

The network SMS centre numbers are automatically set in your Onis 300 :

Send SMS service number (Outgoing number) : 1740 9900

Receive SMS service number (Incoming number) : 0818 365 135

Contact your network provider for more information.

Registration to SMS service is done by sending your first SMS.

There is a charge for sending SMS text messages (Contact your network provider for more information).

**REMINDER !** If there are two **SMS-enabled** phones on your telephone line, you will have to deactivate the SMS feature on one of the devices.

**SMS and Caller Display subscription** : The way to subscribe to and to connect to the Short Message Service (SMS) as well as the SMS function may be operator dependent, and may vary in time. Please contact your network operator for more information. The following information is believed to be exact at the time of writing. It is provided for guidance only, and does not guarantee accuracy over time.

**SMS and Caller Display disclaimer** : The Short Message Service and Caller Display features of the Onis 300 telephone terminal are network operator dependent. The terminal can provide them only if the network offers such features, and if the user has subscribed to these features. The Onis 300 has been carefully developed and tested according to the latest version of the SMS and CLI standards, and is up to date at the time of product release (March 2003). However, Philips cannot take any responsibility and guarantee the interoperability with the operator network in case of standard modification, network modification and/or of incomplete or inaccurate implementation of the standard by the network.

# INFORMATION ON TEXT MESSAGING (SMS) IN THE UK

You must first subscribe to your network provider's Caller Display service.

The SMS service is provided by Bizzyline through your network provider. Bizzyline provides the service and your network provides the infrastructure.

Registration to the SMS service is done by sending your first SMS.

Doing so, you agree with Bizzyline terms and conditions (Call 0906 3020069 (50p/min)).

Bizzyline e-mail contact : [ssservice@bizzyline.net](mailto:ssservice@bizzyline.net)

There is a charge for sending SMS text messages (Contact Bizzyline for more information).

The current network SMS centre (Bizzyline Ltd) numbers set in your Onis 300 are:

Send SMS service number (Outgoing number) : 1470 0911 023 5029

Receive SMS service number (Incoming number): 0161 274 599

Contact Bizzyline for more information.

By default, your Onis 300 is set with the SMS centre 1 (bizzyline).

If you change this setting, the SMS service may not work.

**SENDING SMS FROM A FIXED LINE TO A FIXED LINE** : follow instructions in the user guide.

**SENDING SMS FROM A FIXED LINE TO A MOBILE** : follow instructions in the user guide.

**Warning** : When sending an SMS to a mobile phone, do not enter any destination box as your SMS will not be delivered.

Please note that your phone number appears at the end of the text message between two #.

If you have used 160 characters in the text your number will overwrite the last letters of the message.

**SENDING SMS FROM A MOBILE PHONE TO A FIXED LINE** :

1- Using the **REPLY** option on the mobile, the user has to insert at the end of the text the fixed line telephone number between two #.

Example : when replying to 0212 123456, the user must insert #0212123456# at the end of the message.

2- Using the **SEND** option : send the SMS through the dedicated server (Big Mobile) : 07786201010, which will redirect the SMS to the receiver. The user has to insert at the end of the text the fixed line telephone number between two #.

Example : When sending an SMS to telephone number 0213456789, you need to send it to the server 07786201010 and insert at the end of the text the receiver's number #0212123789#.

We advise you to inform those people wanting to send SMS from mobiles to your Onis 300 of these requirements.

**USING DESTINATION BOX ON YOUR ONIS 300** :

In order to receive an SMS in a specific SMS box, you must have previously sent at least one SMS from this box.

**REMINDER !** If there are two **SMS-enabled** phones on your telephone line, you will have to deactivate the SMS feature on one of the devices.

**SMS and Caller Display subscription** : The way to subscribe to and to connect to the Short Message Service (SMS) as well as the SMS function may be operator dependent, and may vary in time. Please contact Bizzyline for more information. The following information is believed to be exact at the time of writing. It is provided for guidance only, and does not guarantee accuracy over time.

**SMS and Caller Display disclaimer** : The Short Message Service and Caller Display features of the Onis 300 telephone terminal are network operator dependent. The terminal can provide them only if the network offers such features, and if the user has subscribed to these features. The Onis 300 has been carefully developed and tested according to the latest version of the SMS and CLI standards, and is up to date at the time of product release (March 2003). However, Philips cannot take any responsibility and guarantee the interoperability with the operator network in case of standard modification, network modification and/or of incomplete or inaccurate implementation of the standard by the network.